

Pininfarina Senso

Installation and Operating Instructions (English)

V1.1 | September 2023

Important Notice

By using your Pininfarina Senso, you expressly agree to the Pininfarina Hybrid Services Terms and Conditions available on our website.



Contents

Installation and operating requirements.....	5
Internet access	5
Smartphone or device.....	5
OS version	5
Pininfarina Hybrid app version.....	5
Pininfarina Senso watch firmware version	5
Description.....	5
Overview	5
Box contents	5
Watch overview	6
Screen states icon	6
Setting up my watch.....	7
Installing the Pininfarina Hybrid app	7
Installing my watch	7
Setting the time	10
Using the side button of my watch.....	10
Wearing my watch	10
Customizing the settings of my watch.....	11
Enabling notifications.....	11
Activating the Do not disturb mode	11
Activating the Shortcut	11
Activating the Lift on.....	12
Activating the Move hands	12
Activating the Shake off.....	12
Activating the Smart Vibration.....	12
Setting the Subdial feature	12
Setting the Time format.....	12
Tracking my activity	15
Activity detection	15
Checking my progress	15
Changing my goal.....	16
Using the Chrono and Timer	16
Tracking my sleep	17
Retrieving my sleep data.....	17

What is the Sleep score?.....	17
Adding my sleep data.....	17
Setting an alarm	18
Tracking my heart rate.....	19
Enabling the Continuous heart rate mode.....	19
Viewing my heart rate data	20
Frequently asked question about heart rate measurement	21
Tracking my electrocardiogram (ECG)	22
Recording my ECG.....	22
Frequently asked question about ECG.....	23
Tracking my SpO2 (oxygen saturation)	24
How can I perform an accurate SpO2 measurement?.....	25
Activating the pre-loaded sport mode	26
Activating the sport mode	26
Activating the GPS tracking.....	27
Frequently asked questions about GPS tracking	27
Syncing your data.....	27
Performing a factory reset.....	28
Battery life and charging	28
Battery life scenario	28
Recharging the watch	29
Cleaning and maintenance	30
Cleaning my watch	30
Cleaning my wristband.....	30
Changing the wristband	30
Calibrating the hands	31
Updating the firmware version.....	32
Installation and operating instructions manual copyright	33
Legal notice.....	33
Personal data.....	33
Safety instructions	34
Radio frequency (RF) energy	34
Battery and charger	34
Device/Watch	34
Disposal	34
Operating environment.....	35

Medical precautions 35

Specifications 36

 Pininfarina Senso 36

 Sensors 36

 Metrics and features 36

 Connectivity 36

Compatible OS 36

International Warranty 37

Regulatory statements 38

Document release 42

Installation and operating requirements

Internet access

Access to the internet is required to:

- Download the Pininfarina Hybrid app
- Set up your account
- Set up your Pininfarina Senso
- Upgrade the firmware

Smartphone or device

You need an iOS or Android device with operational BLE 5.0, Wi-Fi or 3G/4G to:

- Set up your Pininfarina Senso
- Set up your account
- Retrieve data from your Pininfarina Senso
- Interact with your Pininfarina Senso
- Interact with users

OS version

You need at least iOS 16 or Android 11 to install and run the Pininfarina Hybrid app. BLE compatibility is required to connect your Pininfarina Senso watch.

Pininfarina Hybrid app version

Always use the latest version of the Pininfarina Hybrid app to access all the latest features.

Pininfarina Senso watch firmware version

Make sure your Pininfarina Senso watch is up-to-date with the latest firmware version to access all the latest features. We highly recommend checking for updates after activating the watch.

Description

Overview

Pininfarina Senso – classic watchmaking meets cutting-edge technology, the first smartwatch collection from the renowned Italian design firm. State-of-the-art sensors to help you measure wellbeing and move through the world, housed in an elegant timepiece inspired by Pininfarina's 90-year legacy of pioneering designs.

The iconic legacy of Pininfarina, the groundbreaking innovation of Globics. The Senso hybrid collection finds the perfect balance between classic and contemporary: a traditional dial-and-hands aesthetic, unearthing advanced tools to monitor heart rate, calories, distance, sleep and more.

Box contents

- Pininfarina Senso watch
- Charger
- USB Type-C charging cable
- Cleaning cloth
- Quick start guide
- Instruction manual
- Warranty card

Watch overview

- Ⓐ Screen
- Ⓑ Subdial
- Ⓒ Smart crown
- Ⓓ Back key
- Ⓔ Shortcut key
- Ⓕ Sensors
- Ⓖ Wristband

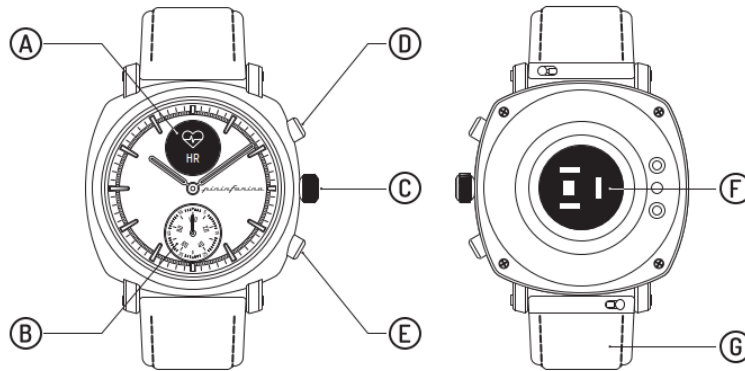

Screen states icon

States Icon



- ✓ Incoming notifications is allowed
- All incoming notifications is muted
- Ⓜ The watch is connected to your phone
- 🔋 The low power mode is enabled
- ⚡ The watch is charging

Setting up my watch

Installing the Pininfarina Hybrid app

If the Pininfarina hybrid app is not already installed on your device, perform the following steps:

1. Scan the QR code or type www.pininfarina-hybridwatchbyglobics.com in your device's web browser.



2. Navigate to APP page.
3. Click the App Store or Play Store download icon.
4. Tap **Get**. The installation process starts.

Installing my watch

To install Pininfarina Senso, perform the following steps:

1. **Place the watch on the charger first** and ensure the watch has more than 50% battery.
2. Open the Pininfarina Hybrid app.
3. Tap **Setup a new device**.

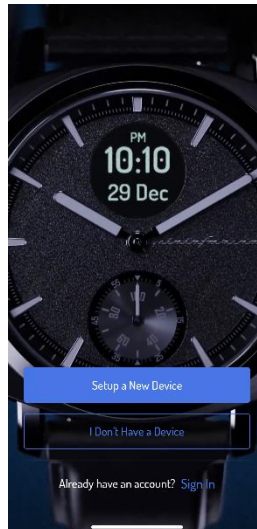

4. Choose Pininfarina Senso (PMH01A) and tap **Ready to setup**.

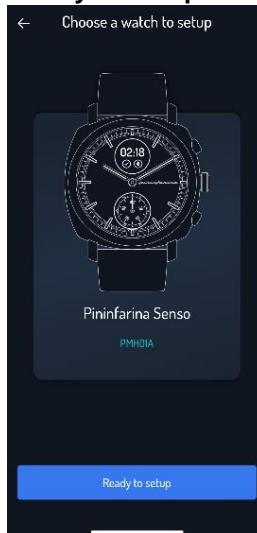

5. Make sure the watch is turned on.

6. Tap **Proceed**. The Bluetooth detection process will start.
7. Tap your watch. If your Pininfarina Senso is not detected by the app, go to your device settings and check if Bluetooth is turned on. Also, ensure that your Pininfarina Senso is close enough to your device.

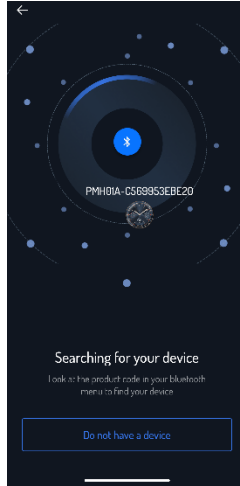

8. Tap **Pair this watch**.
9. Enter the code displayed on your watch's screen and tap **Pair**.

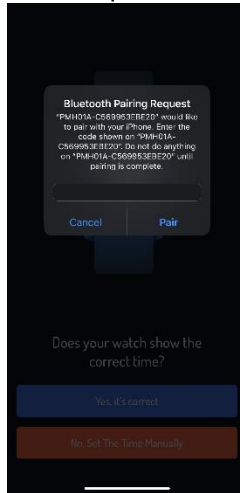

10. If the time is incorrect.
11. Tap **No, Set the time manually**.
12. Following the process to Calibrate the watch hand. Time will be set automatically after the hand calibration.

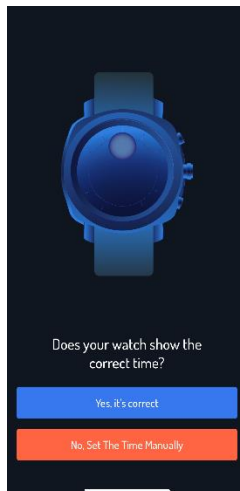

13. Read the Terms and conditions and tap **Proceed**.

14. Enter your email address or sign up using your Apple, Facebook, or Google account.

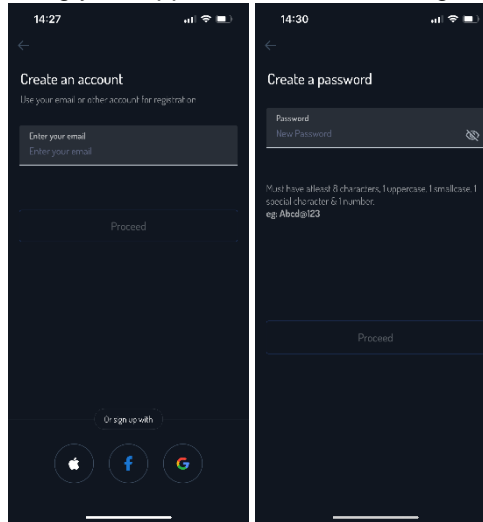

15. You will receive a verification code in your registered email address. Enter the verification code.

16. Create a password and tap **Proceed**.

17. Enter your name, birthday, gender, height, and weight and tap **Proceed**.

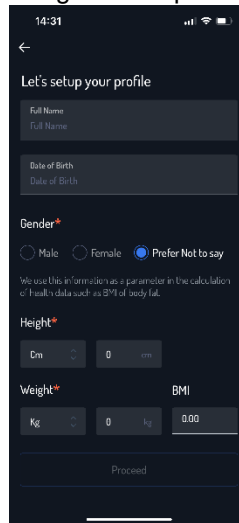

18. Set up your sleep goal or skip.

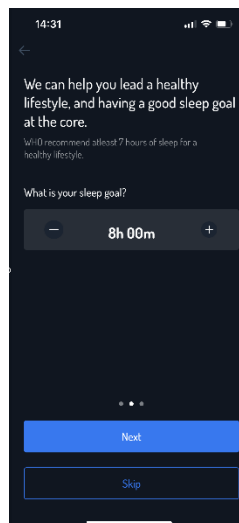

19. Set up your dashboard.

20. Pininfarina Senso watch is now ready for use.

Setting the time

Pininfarina Senso is set up using your paired device, allowing it to automatically display the current time based on the timezone you're in. If you need to change timezones while wearing Pininfarina Senso, open the Pininfarina Hybrid app to sync your watch with your device, and the correct time will be displayed. You don't have to worry about daylight savings time either. If your analog time is incorrect, refer to "Calibrating the Hands" on page 31.

Using the side button of my watch

Pininfarina Senso has two side keys and one smart crown to control the different screens of your watch:

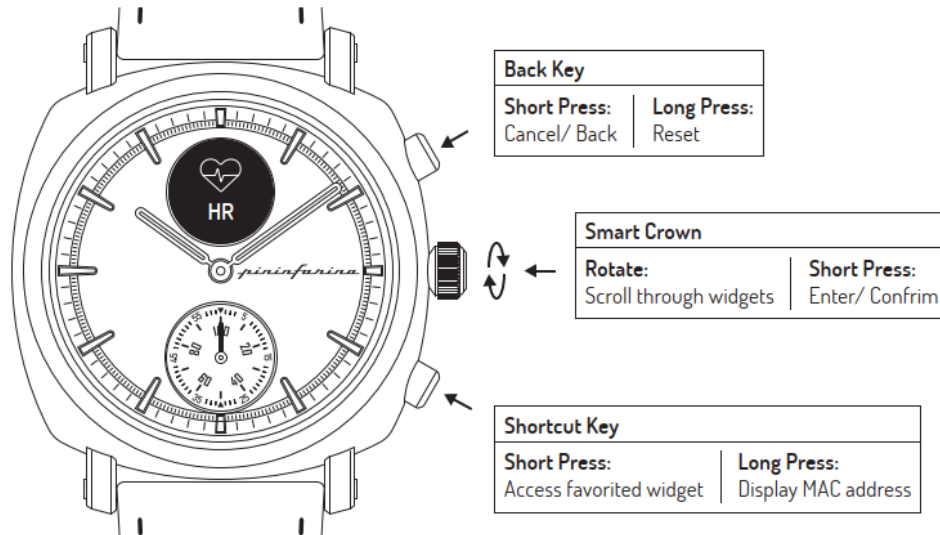

Notes:

- Press the **Shortcut key** allows you to access the favourites widget immediately. You can select the widget from the Pininfarina Hybrid app.
- If your Pininfarina Senso watch becomes unresponsive, hold the **Back key** and **Shortcut key** for 5 seconds to perform a factory reset. (Caution: This will erase all data on your Pininfarina Senso watch and return the watch to its original out-of-the-box state as it was from the factory.)

Wearing my watch

To ensure the accuracy of health data monitoring, wear your watch properly. The wristband should be tight yet comfortable, worn 1cm (approximately 1 finger's width) away from the wrist bone.

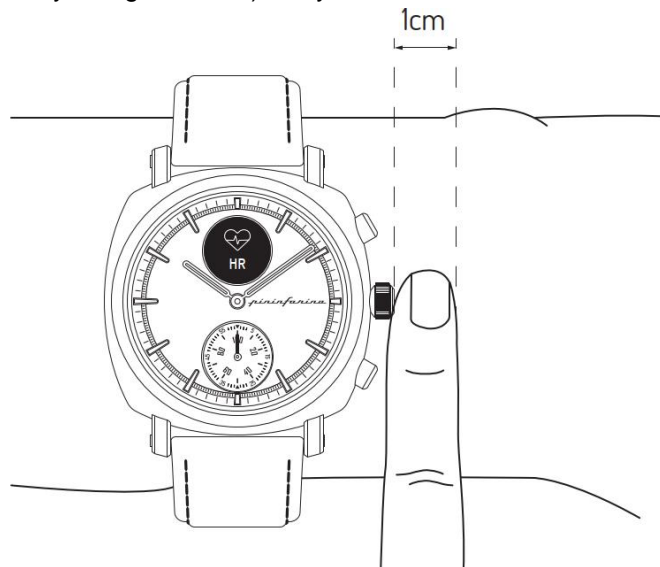

Customizing the settings of my watch

Enabling notifications

To receive notifications for incoming calls, text messages, or emails on your Pininfarina Senso watch, follow these steps.

Third-party apps

1. Open the Pininfarina Hybrid app.
2. Tap **the settings icon on the top right of the Home screen > Device > Reminders & Alerts.**
3. Tap **App alerts.**
4. Enable App Alerts notification and Manage App, then select the notification you want to enable.

Phone calls/Messages

1. Tap **the settings icon on the top right of the Home screen > Device > Reminders & Alerts.**
2. Tap **Calls.**
3. Enable Incoming Call or SMS Alerts notification.

Note for iOS users:

Make sure that notifications are activated on your phone: Allow Notifications or Notification should be enabled to receive notification on your watch.

Note for Android users:

Make sure that the Pininfarina Hybrid app is activated in the Notifications/Control centre on your phone. Tap Notifications/Control centre > App notification > Enable Pininfarina Hybrid app.

Activating the Do not disturb mode

You can choose to activate or deactivate notifications directly on your Pininfarina Senso watch. To do so, press the smart crown and scroll to **Notify**. Press the smart crown to switch to **Mute**, and Do Not Disturb will be activated. You won't receive notifications on your watch anymore. To reactivate notifications, go back to **Notify** and press the smart crown again, then switch to **Allow**.

Activating the Shortcut

The Shortcut feature allows you to access your favorite widget immediately. To activate or deactivate it, open the Pininfarina Hybrid app and **Tap the settings icon on the top right > Device > Shortcut button configuration.** Choose the feature you want to launch with the shortcut key. Once activated, press the shortcut key on your watch to start the selected widget at any time.

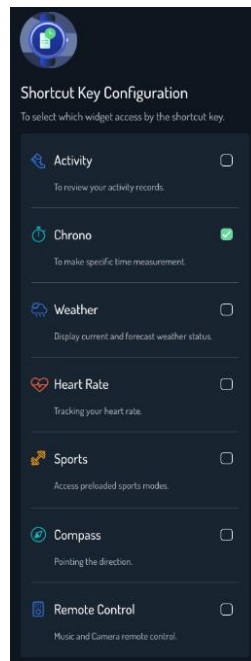

Activating the Lift on

The Lift On feature allows you to light up the screen of your Pininfarina Senso watch without pressing the crown. After activating Lift On mode, you can simply raise your wrist and turn it towards you to light up the screen. To activate or deactivate this feature, go to the **System** menu on your watch by pressing the smart crown and scrolling to **System > Gesture > Lift On**.

Activating the Move hands

The Move Hands feature allows you to see the watch screen without blocking it with the analog watch hand. If the analog watch hand is on top of the screen, it will move away from the screen when you interact with the watch. To activate or deactivate this feature, go to the **System** menu on your watch by pressing the smart crown and scrolling to **System > Gesture > Move Hands**.

Activating the Shake off

The Shake Off feature allows you to disable any notification on the screen without pressing the Back key. Simply shake your hand to turn off any notification immediately. To activate or deactivate this feature, go to the **System** menu on your watch by pressing the smart crown and scrolling to **System > Gesture > Shake Off**.

Activating the Smart Vibration

The Smart vibration feature enable the vibration while you interact with the smart crown. The smart crown will vibrate while you are turning the smart crown. To activate or deactivate this feature, go to the System menu on your watch by pressing the smart crown and scrolling to **System > Smart vibration**.

Notes:

- This feature will consume more battery.

Setting the Subdial feature

The subdial on your Pininfarina Senso watch allows you to see the current second or the percentage of the daily activity goal achieved. To select your preferred settings, go to the Pininfarina Hybrid app and **Tap the settings icon on the top right of the Home screen > Device > Subdial configuration**. You can view the selected information from the subdial.

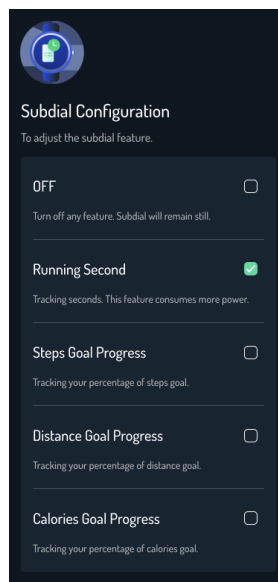

Setting the Time format

You can switch the time format directly on your Pininfarina Senso watch. To do so, press the smart crown and scroll to **System > 12/24H**. Press the smart crown to switch to 12-hour or 24-hour time format.

Features on the watch

Landing screen

Display the time, day and month. While you travel to a location with different time zone. Just simply sync with the App then you will have the updated time on both screen and analog.

Time

Chrono

Pressing the smart crown starts the chrono running, and press again pauses it, leaving the elapsed time displayed. A press of the Back key then resets to zero.

Timer

Set up and measure specific time intervals. Pressing the smart crown starts the timer counter running and presses again to pause it. A press of the Back key then resets to pre-set time.

Alarm

To set an alert at a specific time. The watch will ring and notify users with a vibration and screen on at the appointed time.

Weather

To track the current and coming weather forecast, ensure that you have always allowed and enabled location sharing with the Pininfarina Hybrid app in your phone settings.

Health

HR

Measure and display live heart rate. You can also review the resting heart rate, dynamic heart rate and max heart rate by scrolling through the smart crown.

ECG

Activate ECG test and start the measurement. You can see the ECG readout after synced with the Pininfarina Hybrid App. Also, you can open the App then activate the ECG measurement to read the live waveform through the App.

SpO2

Activate SpO2 test and start the measurement.

Sleep

Display the sleep monitoring data. You can review the sleep duration, light, deep, REM sleep and the awake time in the watch.

Breathe

Activate the breathe training.

Activity

Display daily steps, distance and calories brushed record.

Sports

Activate various sport mode and start measuring your performance.

Remote

Camera

Control remote shutter for the connected device.

Music

Control music playing of the connected device.

Compass

Show the direction the watch is pointing.

Notifications

Allow all

Receive all incoming notification from paired device.

Do not disturb

Mute all incoming notification from paired device.

System

Airplane Mode

Enable airplane mode.

Gesture

Toggle different gesture mode: Lift on, Move hands and Shake off. For more information, refer to page 12.

Hands Calibration

Re-calibrate the misaligned watch hand.

Vibration

Toggle High or Low vibration sequences.

Time format

Toggle between 12-hour and 24-hour time format.

Battery

Display current battery level.

Low power mode

Activate the low power mode to extend the battery life of the watch. This mode will restrict functionality to displaying the time only while temporarily disabling notifications, sleep detection, continuous heart rate monitoring, vibrations, and all other sensors.

Tracking my activity

Activity detection

Your Pininfarina Senso watch enables you to effortlessly track your activity, including steps, distance, and calories burned. Whether you're walking or running, simply wear your watch, and it will automatically track your progress.

The integrated accelerometer sensor counts your steps automatically, while your running activity, distance, and calories are calculated using an algorithm based on your personal data (age, height, and weight).

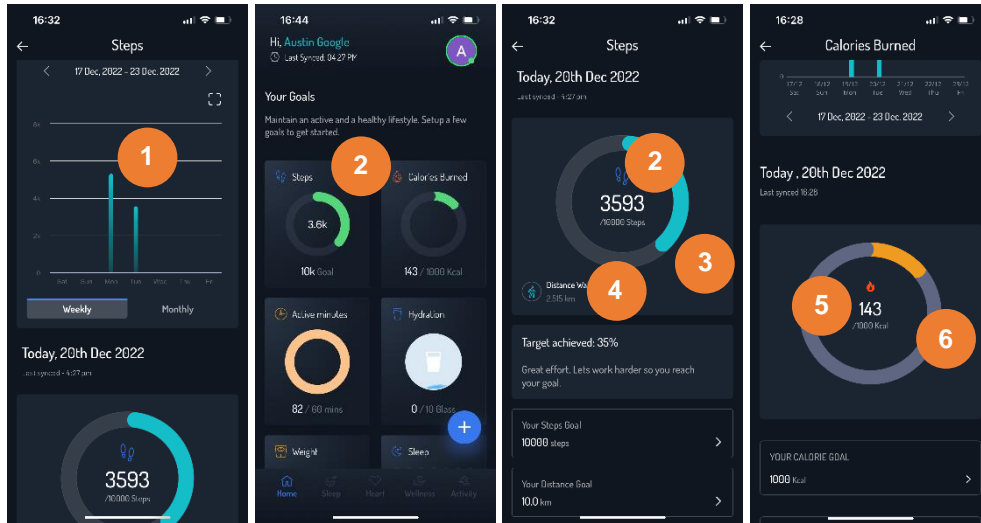

1. Visual representation of the number of steps taken.
2. Total number of steps taken during the day.
3. Percentage of the daily step goal achieved.
4. Estimated distance walked during the day.
5. Estimated calories burned during the day.
6. Estimated percentage of the daily calories burned goal achieved.

Checking my progress

Easily track your daily activity progress with the Pininfarina Senso watch. To check your progress, simply glance at the Activity widget or the Subdial hand on your watch face.

To review in Activity widget:

1. Press the smart crown to turn on the watch display.
2. Scroll to **Activity** screen by turning the smart crown and press it.
3. Use the smart crown to scroll through your Steps, Distance, and Calories progress for the day. You'll see the numbers displayed on the screen, as well as a Subdial hand indicating the percentage of your daily step goal achieved.

To review in Subdial:

First, select your preferred Subdial feature to show the percentage of your daily activity goal achieved. You can easily customize your settings using the Pininfarina Hybrid app. To do so, go to **Home** screen and **Tap the settings icon on the top right of the Home screen > Device > Subdial configuration**. Depending on the Subdial hand position, you can tell what percentage of your daily activity goal you have achieved. For more detailed information, simply log in to the Pininfarina Hybrid app. You'll find helpful graphs that make it easy to see your progress over time.

Changing my goal

You can customize your daily activity goal with Pininfarina Senso. To change your goal, follow these steps:

1. Open the Pininfarina Hybrid app.
2. Select **Activity**.
3. Tap the specific activity for which you want to set a custom daily goal.

Calories burned

4. Scroll down.
5. Tap **Your Calorie goal** to set your calorie burn goal.
6. Select the desired goal.
7. Tap **Save**.

Total Active minutes

4. Scroll down.
5. Tap **Your Active minutes target** to set your goal for active minutes.
6. Select the desired goal.
7. Tap **Save**.

Steps & Distance

4. Scroll down.
5. Tap **Your Steps goal** or **Distance goal** to set your goal for steps or distance.
6. Select the desired goal.
7. Tap **Save**.

Using the Chrono and Timer

The Pininfarina Senso watch has a **Chrono** and **Timer** feature that can be activated from the **Time** menu. To access this menu, press the smart crown and scroll to the **Time** option. From there, you can select the **Chrono** or **Timer** and press and hold the smart crown to stop the measurement. These features are useful for tracking your performance during exercise or other activities that require timing.

Chrono

1. Press the smart crown, turn on the watch display.
2. Scroll to **Time** by turning the smart crown, then press the smart crown.
3. Scroll to **Chrono** by turning the smart crown, then press the smart crown.
4. Press the smart crown again to pause/resume the Chrono.
5. Press back key to reset the Chrono to zero.

Timer

1. Press the smart crown to turn on the watch display.
2. Scroll to **Time** by turning the smart crown, then press the smart crown.
3. The pre-set value is 5 minutes. To set a new timer value, scroll to **Set** by turning the smart crown.
4. Press the smart crown to start setting a new value.
5. Change the value by turning smart crown.
6. Press the smart crown to confirm the new value.
7. Go back to the **Timer**, and you will see the new value displayed.
8. Press the smart crown to start the **Timer**, press again to pause/resume.
9. Press the back key to return to the pre-set value of 5 minutes.

Tracking my sleep

Your Pininfarina Senso watch can automatically track your sleep. All you have to do is wear the watch when you go to bed.

Retrieving my sleep data

You can view your sleep data, go to the **Sleep** screen or **Home** view in the Pininfarina Hybrid app. The app stores your entire sleep history, allowing you to monitor changes over time.

Note: The sleep tracking function requires a minimum of three hours of sleep to collect data. Sleep periods of less than three hours are not currently tracked. Also, if you wear the Pininfarina Senso watch too loosely, the accuracy of the sleep tracking will be affected.



What is the Sleep score?

The sleep score is a simple and intuitive way to understand the quality of your sleep. It measures your sleep each night and assigns a score out of 100 points based on duration, depth, and efficiency.



Adding my sleep data

If you didn't wear your Pininfarina Senso watch during sleep, you can still add sleep data in the Pininfarina Hybrid app.

Follow these steps:

1. Open the Pininfarina Hybrid app.
2. Tap the “ + ” icon in **Home**.
3. Tap **Record New**.
4. Select **Hours Slept**.
5. Tap on **Go to Bed** or **Wake up** to input your sleep data.
6. Tap **Add Sleep Time** to confirm.

Setting an alarm

To enable and set an alarm on your Pininfarina Senso watch, follow these steps:

1. Press the smart crown to turn on the watch display.
2. Scroll to **Time** by turning the smart crown and press the smart crown.
Scroll to **Alarm** by turning the smart crown and press the smart crown to access the alarm settings.
Enabling/disabling the alarm
3. Press the smart crown to toggle the alarm ON/OFF.
To set an alarm
4. Scroll to **Set** by turning the smart crown and press the smart crown.
5. Scroll to adjust the alarm time (Hour) and press the smart crown to confirm.
6. Scroll to adjust the alarm time (Minute) and press the smart crown to confirm.

Notes: If you're using the 12-hour time format, you'll need to adjust the alarm time (AM/PM). Refer to "Setting the Time format" on page 12 to switch the time format of your Pininfarina Senso watch.

Tracking my heart rate

Your Pininfarina Senso watch can help you track your heart rate. To take a measurement, press the smart crown to turn on the watch display. Then, scroll to **Health** by turning the smart crown and press it to access the **HR** screen. Press the smart crown again to start the measurement.

Alternatively, you can use **Continuous Heart Rate** mode to get ongoing heart rate data. Note that this mode takes a measurement every minute and can drain your battery faster. It's also automatically enabled during any sport mode, making it particularly useful for workouts.

For accurate heart rate tracking, make sure the wristband is snug but comfortable and worn about 1 cm (approximately 1 finger's width) away from your wrist bone. You can position the watch on the lower part of your wrist, but we can't guarantee the accuracy of the data in this position.

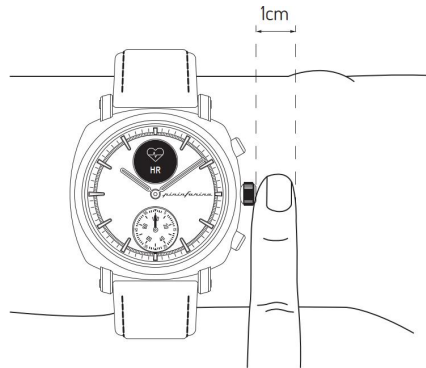

Caution:

- If you have a pacemaker or other internal electronic device, consult your physician before using Pininfarina Senso watch.

Enabling the Continuous heart rate mode

You can easily enable the continuous heart rate mode by your Pininfarina Hybrid app. To do so, follow these steps:

1. Open Pininfarina Hybrid app.
2. Tap **Heart**.
3. Tap **Heart Rate**.
4. Scroll down.
5. Turn on the **Continuous Heart rate Mode**.



Viewing my heart rate data

You can view your latest heart rate measurement directly from your Pininfarina Senso watch. To do so, simply press the smart crown of the watch and rotate it to the **Health** option. Press the smart crown to go to the **HR** screen. Note that going to the **HR** screen will trigger a new heart rate measurement. After the measurement is completed, you can view your resting, dynamic, and maximum heart rates by scrolling the smart crown.

If you want to see the full history of your heart rate measurements, you can log in to the Pininfarina Hybrid app.



Frequently asked question about heart rate measurement

When does Pininfarina Senso watch measure your heart rate?

Pininfarina Senso watch measures your heart rate continuously during a workout in Sport mode. It also measures your heart rate throughout the day when you turn on the continuous heart rate mode. However, the time between these background measurements may vary based on your activity.

How does Pininfarina Senso watch measure your heart rate?

The optical heart sensor in Pininfarina Senso watch uses photoplethysmography (PPG) to measure your heart rate. It calculates the number of times your heart beats each minute. The optical heart sensor supports a range of 30-210 beats per minute. Additionally, the optical heart sensor is designed to compensate for low signal levels by increasing both LED brightness and sampling rate.

Pininfarina Senso watch also measures your heart rate when recording an electrocardiogram (ECG). It has built-in electrodes in the watch case body that can measure the electrical signals across your heart when used with the ECG recording. To use the electrical heart sensor to measure your heart rate, select the ECG test in the Pininfarina Senso watch and follow the instructions.

Caution:

- Pininfarina Senso watch cannot detect heart attacks. If you experience chest pain, pressure, tightness, or what you think is a heart attack, call emergency services immediately or consult a doctor.
- Pininfarina Senso watch does not detect all instances of AFib, and people with AFib may not get a notification.
- Pininfarina Senso watch is not intended for users with known arrhythmias, AFib, or users under 22 years old.
- You should not interpret or take clinical action based on the Pininfarina Senso watch/Pininfarina Hybrid app output without consulting a qualified healthcare professional.
- If you're not feeling well, you should talk to your doctor even if you don't get a notification.
- Do not change your medication without talking to your doctor. The Pininfarina Senso watch is not intended to replace traditional methods of diagnosis or treatment.
- In some instances, the notification may indicate the presence of an irregular heart rhythm.
- Heart rate, ECG, and blood oxygen saturation (SpO2) measurements/data are for information use only, and no responsibility is accepted for any consequences of incorrect readings.
- Users in the USA can review the waveform and average heart rate only in the ECG section of the App.

Tracking my electrocardiogram (ECG)

What is an ECG?

An ECG, or electrocardiogram, is a test that measures the electrical activity of the heart and produces a graphical representation of the heart's electrical activity. With each heartbeat, an electrical wave travels through the heart, causing it to contract and pump blood. Pininfarina Senso can sense the electrical activity of the heart at a distance through the left and right arm and use this data to record an ECG reading.

Recording my ECG

To record your ECG, perform the following steps:

1. Ensure the watch is snug on your wrist, refer to “Wearing my watch” on page 10.
2. Press the smart crown to turn on the watch display.
3. Scroll to **Heart** by turning the smart crown and press the smart crown.
4. Scroll to **ECG** by turning the smart crown and press the smart crown.
5. Starting the ECG measurement.
6. Keep your hand/finger on the watch case and remain still.
7. Completed.
8. Open **Pininfarina Hybrid App > Heart > ECG**
9. Syncing ECG data to the App
10. You can see your recorded waveform and result

Notes:

- Open the Pininfarina Hybrid app before starting the ECG measurement, you will be asked if you want to see your ECG signal in real time in the Pininfarina Hybrid app.

Results you may see:

Sinus Rhythm: This means your heart is beating in a uniform pattern.

Abnormal: This means your heart might beat in a non-uniform pattern or the ECG measurement is of poor quality. If you see this result, you should try recording your ECG again or consult a qualified healthcare professional.

Notes:

- The ECG data displayed by the ECG feature is intended for information use only. The user is not intended to interpret or take clinical action based on the device output without consultation of a qualified healthcare professional.
- You should not interpret or take clinical action based on the ECG data displayed without consulting a qualified healthcare professional.
- Users in the USA can review the waveform and average heart rate only in the ECG section of the App.

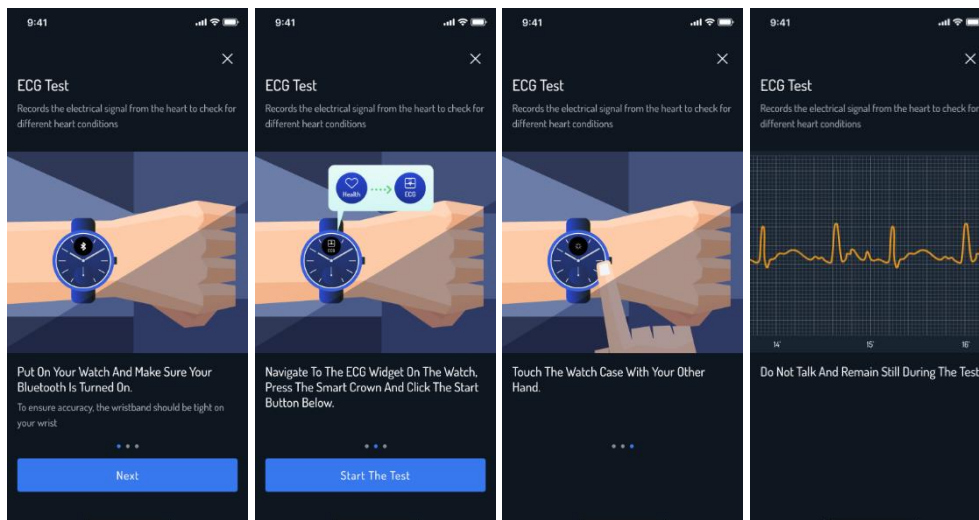

Frequently asked question about ECG

How does Pininfarina Senso watch provide an electrocardiogram (ECG)?

Pininfarina Senso watch features two electrodes to ensure measurement accuracy. One electrode is integrated inside the main body of the watch, and the second one is in the stainless steel rim of the case back.

How can I see the results?

You can view the results on the Pininfarina Hybrid app. After finishing the ECG test by your Senso, it is necessary to activate the app and synchronize the ECG data with our server for comprehensive analysis. The results can be accessed within the app. All recordings are stored in the app's history and can be easily shared with a doctor or healthcare professional.

How can I share my result or act on them?

The data collected by Pininfarina Senso watch and visualized in the Pininfarina Hybrid app can be easily shared with others.

Can Pininfarina Senso watch detect arrhythmias?

The Pininfarina Senso watch is not cleared to detect or communicate any other results, rhythms, or arrhythmias. However, the watch records a single-lead ECG, and any arrhythmia that appears on this type of ECG is likely to appear on the ECG record. Users may present this recording to a specialist for diagnosis. However, users should not interpret or take clinical action based on the Pininfarina Senso watch/Pininfarina Hybrid app output without consulting a qualified healthcare professional.

Important information regarding ECG recordings

- Pininfarina Senso watch cannot detect signs of a heart attack. If you believe you are experiencing a medical emergency, please call emergency services.
- Do not take recordings when Pininfarina Senso watch is close to strong electromagnetic fields (e.g., electromagnetic anti-theft systems, metal detectors).
- Do not take recordings during a medical procedure (e.g., magnetic resonance imaging, diathermy, lithotripsy, cautery, and external defibrillation procedures).
- Do not take recordings when Pininfarina Senso watch is outside the operating temperature range (5°C - 35°C).
- Do not use Pininfarina Senso watch to diagnose heart-related conditions.
- Do not use Pininfarina Senso watch with a cardiac pacemaker, ICDs, or other implanted electronic devices.
- Do not take a recording during physical activity.
- Do not change your medication without consulting your doctor.
- Pininfarina Senso watch is not intended for use by individuals aged under 18 (21 in the US).
- Consult your doctor if your heart rate is under 50 bpm or over 120 bpm at rest, and if this is an unexpected result.
- Interpretations made by the ECG software are potential findings, not a complete diagnosis of cardiac conditions.
- Users should not interpret or take clinical action based on the Pininfarina Senso watch output without consulting a qualified healthcare professional.
- The data generated by Pininfarina Senso watch is not intended to replace traditional methods of diagnosis or treatment.
- Pininfarina S.p.A. and Globics Technology Limited do not guarantee that users are not experiencing arrhythmia or other health conditions when Pininfarina Senso watch labels an ECG as "Sinus Rhythm".
- Users should notify their physician if they detect possible changes in their health.
- Users in the USA can review the waveform and average heart rate only in the ECG section of the App.

Tracking my SpO2 (oxygen saturation)

What is SpO2?

SpO2 stands for peripheral capillary oxygen saturation, which estimates the amount of oxygen in the blood. Specifically, it represents the percentage of oxygenated hemoglobin compared to the total hemoglobin in the blood. SpO2 is often considered the fifth vital sign, alongside pulse, respiratory rate, blood pressure, and body temperature.

How is it measured?

Pulse oximetry is an indirect, non-invasive method to measure SpO2, which means it does not involve inserting instruments into the body. The method emits and absorbs a light wave that reflects off the blood vessels or capillaries in the wrist.

The Pininfarina Senso watch uses a multi-wavelength sensor called a PPG (photoplethysmography) sensor that emits and measures red and infrared reflections on the blood vessels in the wrist. An algorithm then compares the reflection at each wavelength to calculate the SpO2 value.

What is normal SpO2 level?

A SpO2 value is represented by a percentage. For instance, if your Pininfarina Senso watch displays 97%, this means each red blood cell is 97% oxygenated and 3% non-oxygenated hemoglobin.

Good blood oxygenation is essential to supply the energy your muscles need to function, which increases during sports activities. If your SpO2 value is regularly below 90%, it could indicate poor blood oxygenation, also known as hypoxemia.

SpO2 values usually range between 90% and 100%:

- 95% to 100%: Normal.
- 90% to 94%: Below Average. This reading indicates that your blood oxygen level is below average but still normal. The results can vary based on several factors, such as your health profile (e.g., if you smoke, have asthma, are very athletic, have tattoos, have known conditions like hypotension, etc.), environment (altitude, temperature), and how the measurement is taken (standing or sitting position, wristband tightening, etc.). We recommend checking for best practices and training to improve your gesture.
- Below 90%: Low. The value can be a possible sign of hypoxemia. The results can vary based on several factors, including your health profile, environment, and how the measurement is taken. We recommend checking for best practices and repeating the measurement. If results in this range are associated with symptoms, contact your doctor or a health professional who can help you diagnose and take preventive actions. Symptoms include being short of breath after exertion, coughing, fast or slow heart rate, rapid breathing, sweating.

Notes:

As the elevation increases, SpO2 gradually decreases. It is usually lower upon arrival at a given altitude and rises afterward.

Classification	SpO2 value (Measurement in %)	Impact on the human body	Altitude reference
Normal	95 - 100	Normal	0 - 2000m
Below average	90 - 95	Altitude sickness, acclimatization recommended	2000 - 3500m
Low	80 - 90	Critical, very frequent altitude sickness, consult specialist immediately	3500 - 5800m
Abnormally low	<80	Severe hypoxia, hospitalization needed	5800 - 7500m

How can I perform an accurate SpO2 measurement?

The accuracy of a one-time measurement with the Pininfarina watch depends on the measurement conditions. To better monitor SpO2 and create a trend, multiple measurements should be taken.

To ensure that the measured value is as close as possible to the true physical value, make sure your watch is properly positioned and tightened, and that your technique follows these best practices. The wristband should be snug but comfortable, and the watch should be worn approximately 1cm (or about one finger's width) away from the wrist bone.

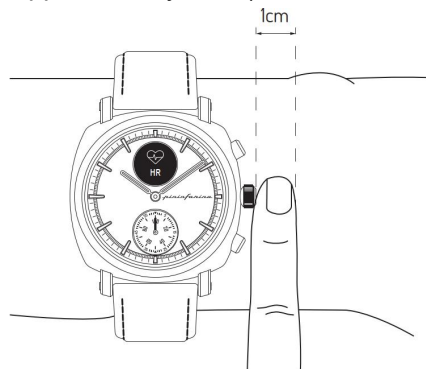

How to perform an accurate SpO2 measurement

1. Ensure that you are wearing the watch and have been resting for at least 10 minutes since your last workout session.
2. Slowly breathe and relax yourself.
3. Rest your arm on a table with your hand relaxed and open.
4. Press the smart crown of the watch and scroll to the SpO2 widget. Press the smart crown to select SpO2.
5. Gently press the top of the watch with your other hand to improve the contact between your skin and the watch, making sure that the smart crown of the watch remains flush with the skin.
6. Do not move or speak during the measurement.
7. Low pulsatile signal can often occur when your hands and/or arms are cold. In this case, rubbing the skin that will be in contact with or around the sensor may help.

Important information regarding SpO2 measurement

Factors that may degrade the performance of reflectance pulse oximetry and heart rhythm analysis via photoplethysmography (ECG) include:

- Bright sunlight
- Strong electromagnetic fields
- Failure to apply the device correctly (loose wristband application, not on top of the wrist)
- Tattoos on the wrist in the region of the optical sensor
- Excessive motion of the arm, wrist, or fingers
- Low perfusion caused by ambient temperature below the recommended operation range or by certain conditions such as Raynaud's syndrome
- Significant levels of dysfunctional hemoglobin (carboxyhemoglobin, methemoglobin)
- Venous pulsations
- Intravascular dyes such as cardio green or methyl blue
- Blood-flow restrictions due to arterial catheters, blood pressure cuffs, or infusion lines
- Hypotension, serious vasoconstriction, serious anemia, or hypothermia
- Cardiac arrest or shock

Activating the pre-loaded sport mode

How does the Sport mode work?

Pininfarina Senso can track up to 15 different types of physical activities. To select your sport mode, simply go to the Sport screen on your watch and scroll through the available activities using the smart crown. Once you've found the activity you want to track, press the smart crown to start your workout.

Notes:

- You can pause your workout at any time by pressing the **Smart crown**. To resume your workout, press the **Smart crown** again.
- To stop your workout entirely, first pause the sport mode by pressing the **Smart crown**, then long-press the **Smart crown** to exit the mode.
- During your workout, you can review your duration, heart rate, and distance data by turning the smart crown.
- While in sport mode, Pininfarina Senso continuously tracks your heart rate and duration. After your workout, an overview of your performance will be available in the Pininfarina Hybrid app.
- GPS tracking is available for Running, Treadmill, Cycling, Walking and Hiking sport modes. To track your route, ensure that you have always allowed the Pininfarina Hybrid app to access your location in your phone setting before starting your workout.

Activating the sport mode

Navigate to the **Sport** menu on your Pininfarina Senso watch and scroll through the available activities using the smart crown. Select the activity you want to track, and your workout session will begin. During your workout, the watch will continuously monitor your heart rate.

On the digital display, you can scroll through a timer that keeps track of your workout duration, the distance you have covered, and your real-time heart rate. To pause or stop the sport mode, simply press or hold the **Smart crown**.

All heart rate data is automatically synchronized to the Pininfarina Hybrid app. A workout log will appear in the Activity page of the app for each workout, where you can view details about your session, including a heart rate graph and the time spent. For more accurate heart rate readings during your workouts, ensure that the watch is snugly fitted on your wrist.

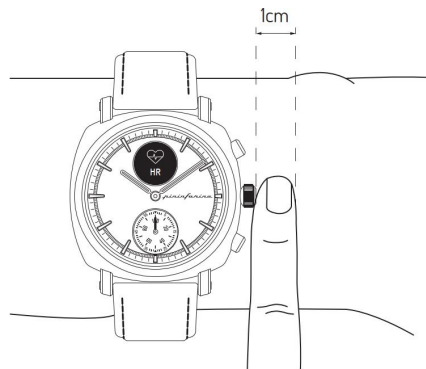

Activating the GPS tracking

To activate GPS tracking, launch a distance-based outdoor activity sport mode such as Running, Treadmill, Cycling, Walking or Hiking by following these steps:

1. Go to the **Sport** menu of your Pininfarina Senso watch.
2. Scroll the side button of the watch to navigate through the activities and select the activity of your choice to start your workout session.
3. A notification will appear on your paired phone asking for permission to track your location.
4. Press or hold the **Smart crown** until it vibrates to pause or stop your workout session.

Notes:

- Your Pininfarina Senso watch must be connected via Bluetooth, and GPS tracking requires enabling location settings on your smartphone.
- GPS tracking will only be possible if the low power mode is deactivated on your smartphone.

How does GPS tracking work?

GPS tracking allows you to track the route you've covered on a map in the Pininfarina Hybrid app while running with your smartphone. Additionally, your workout's real-time duration is displayed on your phone.

Frequently asked questions about GPS tracking

Why do I need to have my location services always on?

The Pininfarina Senso watch and Pininfarina Hybrid app require access to your location data when a distance-based outdoor workout is tracked. GPS tracking does not significantly impact your smartphone's battery life. Please ensure that you authorize the Pininfarina Hybrid app to always allow access to your location in your phone settings.

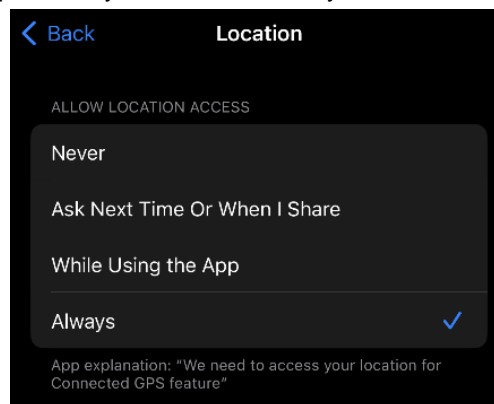

Which sport modes are connected GPS available?

Connected GPS is available for Walking, Running, Cycling, and Hiking sport modes on the Pininfarina Senso watch.

Syncing your data

To sync your data, simply open the Pininfarina Hybrid app and scroll down on the home screen. Your Pininfarina Senso watch will automatically sync your data with the app. Keep in mind that your watch must be in close proximity to your paired device and Bluetooth must be enabled on your device in order to sync your data. It's important to note that the Pininfarina Senso watch has limited memory, so it's essential to regularly open the app and sync your data to prevent losing any information.

Performing a factory reset

A factory reset of your Pininfarina Senso watch will erase all stored data.

Notes:

- Synced data from the Pininfarina Hybrid app will not be removed by a factory reset.
- All un-synced data will be permanently lost.

To dissociate your Pininfarina Senso watch, follow these steps:

1. Open the Pininfarina Hybrid app and tap **Settings icon** (the icon on the top right-hand side of the app in Home screen). Choose the Pininfarina Senso watch from the device list, scroll down, and tap **Unpair**.
2. Go to your mobile device's **Settings**, select **Bluetooth**, and find PMH01A in the list of devices. Select it and tap **Forget/Unpair** the watch.
3. Press and hold the **Back** key and **Shortcut** key for **5 seconds** to perform a factory reset.
4. You can now reconfigure the watch.

Battery life and charging

Battery life scenario

Pininfarina Senso is equipped with a battery that surpasses the expectations of those familiar with the world of connected watches. Learn how to optimize its performance for extended battery life.

Pininfarina Senso is designed to detect various pathologies whose symptoms may be mild or episodic. To avoid missing these signs, Pininfarina Senso's battery life exceeds what is typically found in the market. Although it is designed to run for up to 30 days before requiring a recharge, the battery life is affected by use. Here are examples of two scenarios:

	Long battery (30-day use scenario)	Typical (20-day use scenario)
Health, Activity and Sleep:	5000 steps per day No sport mode enabled Heart rate, ECG and SpO2 measurement once per day 8 hours of sleep tracking per day Continuous Heart rate mode off	5000 steps per day 30 minutes workout tracking 3 times/week Heart rate, ECG and SpO2 measurement once per day 8 hours of sleep tracking a day Continuous Heart rate mode is off
Settings:	5 notifications a day All gesture modes off Smart vibration off No alarm set	30 notifications a day Lift on mode is on (10 times per day) Smart vibration off Alarm set

Factors that can affect the expected battery life of your Pininfarina Senso include your usage patterns and the quality of your signal and network. Your smartphone model, as well as environmental factors, can also have an impact. Keep in mind that actual battery life may differ from the estimates outlined above depending on these and other factors.

Recharging the watch

To recharge your Pininfarina Senso watch, simply use the provided charger. When the battery level reaches 20%, the watch enters low power mode and only displays the analog clock and step tracking. To ensure proper charging, make sure the back of the watch is dry and free of debris and that the watch is properly positioned on the charger.

Notes:

- Using chargers or cables other than the one provided may void your warranty and cause damage.
- Keep the charger, charging cable and device in a dry environment while charging.
- Do not touch the charger or device with wet hands, and ensure that the charger is not exposed to rain or liquid. A wet environment can cause an electric shock or short circuit, which may lead to dangerous fire, explosion or scald.
- Whenever the device becomes extremely hot, immediately remove the watch, turn off the power, and contact the manufacturer's after-sales service personnel for assistance to prevent scald or battery explosion.

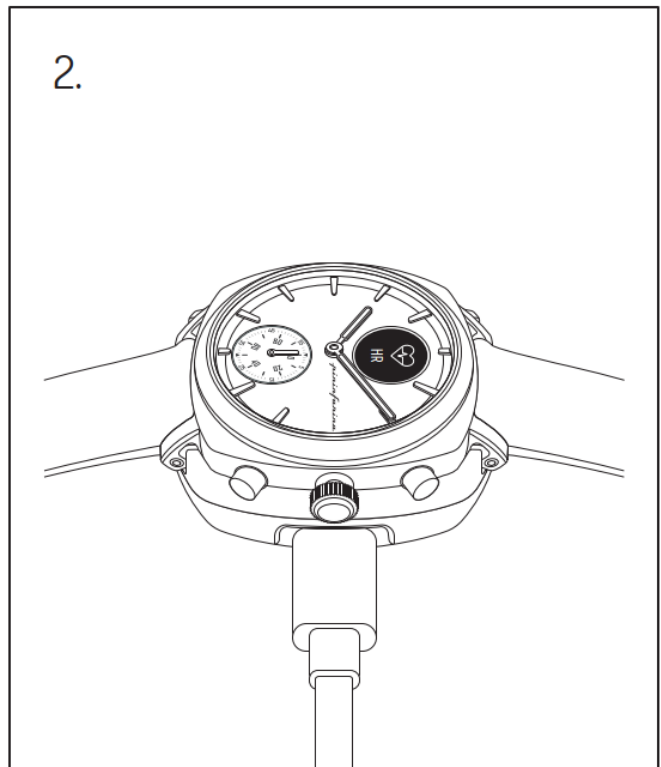
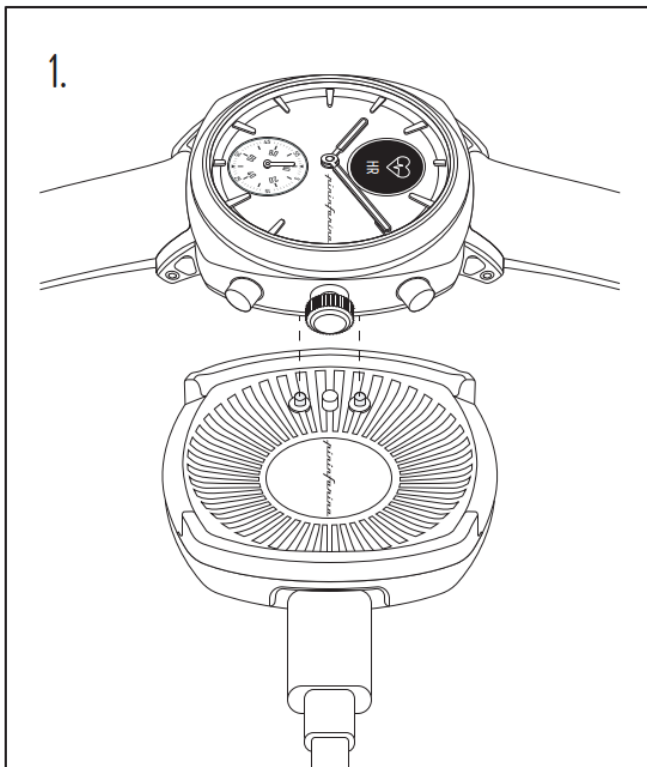

Cleaning and maintenance

Cleaning my watch

1. Use a lint-free cloth moistened with warm water to clean the glass and casing of your Pininfarina Senso.
2. Dry the casing of your Pininfarina Senso with a soft cloth.

Notes:

- If the side button of your Pininfarina Senso appears to be stuck, we recommend rinsing the casing of your watch with clear, warm water and drying it with a lint-free cloth.
- If the bottom sensor crystal becomes dirty with debris and sweat, it can prevent the watch from accurately measuring heart rate, ECG, and SpO2. If this occurs, clean the crystal with warm, soapy water and then dry it with a soft cloth. The watch should also be cleaned after each workout.

Cleaning my wristband

Leather wristbands

- Wipe down the band with a lint-free cloth. You can lightly dampen the cloth with water.
- Leather wristbands are not water resistant.
- Leather wristbands should not be worn during workouts.
- For light-coloured leather wristbands, avoid direct contact with dark-colored clothing as color transfer may occur.
- Sunlight, humidity, cosmetic products, and abrasive chemicals (such as cleaning agents or insect repellent) can damage your wristband.

Important notes:

- The wristband's colour tends to fade over time.
- Your wristband should be cleaned regularly.
- Moisturizers, soaps, and sweat residues can cause skin irritations.
- If you experience skin irritation, we recommend consulting with a dermatologist before wearing your Pininfarina Senso again.

Changing the wristband

You can easily change the wristband of your Pininfarina Senso thanks to the quick-release spring bars that it uses. The watch requires wristbands that are 22 mm wide.

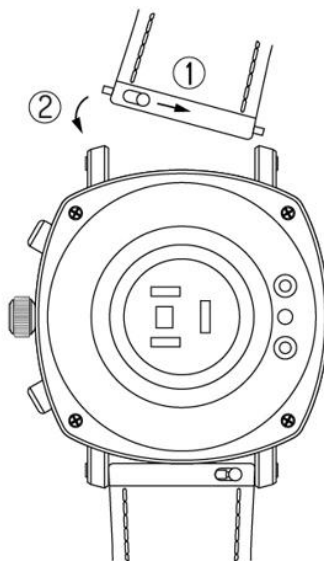

Calibrating the hands

If you notice that the analog time displayed on your Pininfarina Senso is incorrect, you may need to calibrate the hands. Follow these steps to calibrate the hands:

Pininfarina Hybrid app

1. Open the Pininfarina Hybrid app.
2. **Tap on the setting icon on the top right-hand side of the Home screen > Device > Hand calibration**
3. Make sure your watch is placed close to your paired device.
4. Tap **Proceed**.
5. Use the wheel to move the hour hand to the 9 o'clock position and tap **Next**.

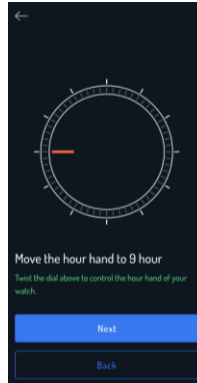

6. Use the wheel to move the minute hand to the **3 o'clock position** and tap **Next**.

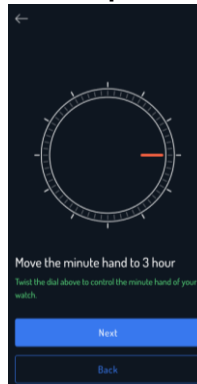

7. Use the wheel to move the second hand to the **12 o'clock position** and tap **Done**.
After completing these steps, your Pininfarina Senso should be properly calibrated, and the hands will move to their correct position to display the current time.



Pininfarina Senso watch

1. Turn on the watch display.
2. Scroll down to **System > Calibrate hands**
3. Press the smart crown to confirm your selection.
4. Turn the smart crown to move the hour hand to **9-hour** and then press the smart crown to confirm.
5. Turn the smart crown to move the minute hand to **3-hour** and then press the smart crown to confirm.
6. Turn the smart crown to move the second hand to **12-hour** and then press the smart crown to confirm.
7. Press the back key to exit.
8. Your Pininfarina Senso is now properly calibrated, and the hands will display the correct time.

Updating the firmware version

To ensure that you have access to the latest features for your Pininfarina Senso, we regularly release new firmware versions. You will receive a prompt from the Pininfarina Hybrid app when a new firmware version is available.

Before updating your firmware version, be sure to sync your Pininfarina Senso to avoid any data loss. It's also important to make sure your watch is charged and has at least 50% battery level. We recommend that you place the watch on the charger during the update progress.

If you want to check for firmware updates or force their installation, follow these steps:

1. Open the Pininfarina Hybrid app and **tap on the setting icon on the top right-hand side of the Home screen > Device > Check for firmware updates.**
2. You can also view which firmware version your Pininfarina Senso is currently using on this page.
3. Tap **Check for updates.**
Make sure that your Pininfarina Senso is placed close enough to your paired device.
4. If your watch is not up to date, the app will prompt you to install the new firmware version.
5. Tap **Install.**
6. Wait for the update to complete.
7. Tap **Done.**

Installation and operating instructions manual copyright

This installation and operating instructions are protected by Intellectual Property law and copyright. Any reproduction, modification, representation and/or publication, without Globics (Globics Technology Limited) or Pininfarina (Pininfarina S.p.A.) prior approval is strictly prohibited. You may print this installation and operating instructions manual for your personal use only.

Legal notice

By using your Pininfarina Senso, you expressly agree to the terms and conditions of Pininfarina services available on our website. This product is not a medical device and should not be used to diagnose or treat any medical condition.

Personal data

- Make sure to read our privacy policy, which you can find on our website.
- Ensure that your Pininfarina Senso account password is secure enough to restrict access to your account. It should be at least eight characters long, have mixed case, and use a combination of alphanumeric and special characters.
- You can remove your personal data and account from the Pininfarina Hybrid app by **Tap the settings icon on the top right of the Home screen > View profile > Delete Account.**

Safety instructions

Radio frequency (RF) energy

Exposure to RF Energy & Device Operation Your watch contains a transmitter and receiver of RF energy. It is designed to comply with regulatory requirements concerning human RF exposure. For optimal device performance, and to stay within the RF exposure guidelines, wear your watch as indicated in your user's guide.

Follow Instructions to Avoid Interference Problems.

Turn off your watch in any location where posted notices instruct you to do so, such as hospitals or health care facilities. In an aircraft, turn off your watch whenever instructed to do so by airline staff. If your watch offers an airplane mode or similar feature, consult airline staff about using it in flight.

Operating range:

Bluetooth: 2402-2480MHz

Maximum RF output power (e.i.r.p.): 7.05dBm for CE

Battery and charger

The battery is not intended for user replacement, do not replace the battery by yourself. Battery related operations must be performed by the manufacturer or the manufacturer's authorized service provider.

Do not place the battery or the device under direct sunlight, close to open flames, heat, microwave ovens, ovens, etc.

Avoid dropping or piercing the device or battery as such damage can cause battery leakage, overheating, igniting or exploding.

If the battery leaks, prevent your skin or eyes from the leakage. If your skin or eyes have been exposed to the leakage, rinse immediately with clean water and go to the hospital for medical treatment.

Please use the manufacturer's approved charging accessories for charging. Using incompatible accessories may cause fire, explosion or scalding.

Keep the charger, charging cable and device in a dry environment while charging.

Do not touch the charger or device with wet hands, and ensure that the charger is not exposed to rain or liquid. A wet environment can cause an electric shock or short circuit, which may lead to dangerous fire, explosion or scald.

Whenever the device becomes extremely hot, immediately remove the watch, turn off the power, and contact the manufacturer's after-sales service personnel for assistance to prevent scald or battery explosion.

Device/Watch

No modification of this equipment is allowed. Do not immerse the watch or batteries in water or other liquids. Be careful not to expose the watch to solvents, mercury, cosmetic sprays, detergents, adhesives or paints, as the case, bracelet, strap, etc., may become discoloured or damaged. Do not leave the watch exposed to a heat source or in a high-temperature location. To prevent the possibility of damage, store it out of direct sunlight. Do not operate and store the watch outside the temperature ranges of 0°C to 45°C. If your watch has a protective film or a sticker on the case back, make sure to peel them off before using the watch. Otherwise, sweat getting under them may rust the watch case back. Please clean the watch and strap periodically with clean water and then use a dry soft cloth to dry up the watch. Make sure do not use shampoo, soaps, and other chemicals to wipe the dirt in avoidance of irritating skin or corrosion of the watch.

Disposal

The watch is classified as an electrical and electronic equipment. Such items should not be mixed with general household waste and must be taken to dedicated collection points at the end of their working life for proper treatment, recovery, and recycling.

Operating environment

The Maximum operating temperature of the device is between 0° C and 45° C, but it is recommended that the user's suitable operation temperature is between 5 ° C and 35 ° C to ensure the best user experience.

The device should be stored between -20 ° C and 45 ° C. If the storage temperature or operating temperature is beyond the range, the watch may be damaged, and the battery life will be shortened.

Do not use or store this device near flammable or explosive equipment.

A cautionary note on water resistance: The Pininfarina Watch is 5 ATM Water Resistant. This means you can safely submerge your watch down to 50 meters, expose it to rain, splashes and other minor contact with water. The watch is not intended for high-impact water sports, diving, or extreme water pressure. Please note that components such as the smart crown and buttons are important to avoid being pressed when underwater, especially when in contact for prolonged periods of time. Likewise, leather bands should be kept dry at most times to prevent structural damage and deformation. Before charging, always ensure the watch is dry. If the watch has been in contact with salt water or sweat, rinse it thoroughly and dry it to avoid damage.

Medical precautions

The watch is not designed to continuously monitor vital signs in critical or potentially dangerous conditions. The vital signs measured by this watch cannot identify all diseases. If you think you may have a heart attack (myocardial infarction) or are facing a medical emergency, call the emergency services. If you use an implantable pacemaker or defibrillator, or another medical device, consult your healthcare provider and the device manufacturer's directions before using this watch.

- The ECG data displayed by the ECG feature is intended for informational use only. The user is not intended to interpret or take clinical action based on the device output without consultation of a qualified healthcare professional. Users in the USA can review the waveform and average heart rate only in the ECG section of the App.
- The Pininfarina Senso watch is not intended to replace traditional methods of diagnosis or treatment.
- The Pininfarina Senso watch is not intended to provide or to replace a diagnosis by a physician or qualified health care professionals.
- The ECG feature is not intended for use by people under 22 years old.
- The Pininfarina Senso watch is not designed to continuously monitor vital signs in critical or potentially dangerous conditions. The vital signs measured by Pininfarina Senso and Pininfarina Hybrid Watch app cannot identify all diseases. It cannot detect heart attack (myocardial infarction) or any medical emergency.
- If users use an implantable pacemaker or defibrillator, or another medical device, consult their healthcare provider and the device manufacturer's directions before using Pininfarina Senso and Pininfarina Hybrid Watch app.
- Always keep the Pininfarina Senso watch more than 20 centimeters (8 inches) from the pacemaker or defibrillator when the watch is turned ON.
- DO NOT wear the Pininfarina Senso watch during a medical procedure (e.g. magnetic resonance imaging, diathermy, lithotripsy, cautery and external defibrillation procedures.)
- Take OFF the Pininfarina Senso watch immediately if users have any reason to suspect that interference is taking place.
- The optical heart rate sensor emits green, red, infrared light and flashes occasionally. Users should consult their physician if users have epilepsy or are sensitive to bright or flashing lights.
- Heart rate, ECG, and blood oxygen saturation (SpO2) measurements are for information use only, and no responsibility is accepted for any consequences of incorrect readings. Globics does not guarantee that users are not experiencing an arrhythmia or other health issues even in the absence of a notification from the pulse rate feature. Although optical heart rate monitors and pulse oximeter sensors typically provide an accurate estimate of a user's heart rate and blood oxygen saturation. It is possible that the oxygen saturation readings may be inaccurate under certain circumstances, including the type and intensity of activity, the user's physical characteristics, the fit of the device, the location of the device, and movement of the user. If users experience any changes in their health, users should notify their physician.
- Movements and other metrics are tracked by sensors in the Pininfarina Senso watch. They are intended to provide a close estimate of user's activity and metrics tracked, but they are not guaranteed to be completely accurate, including steps, distance, calories, sleep, heart rate, oxygen saturation data.
- Do not self-diagnose or self-medicate on the basis of this device without consulting the doctor. In particular, do not start taking any new medication or change the type and/or dosage of any existing medication without or prior approval.

Specifications

Pininfarina Senso

- Case: 316L stainless steel
- Wristband: Italian genuine leather strap
- Wristband clasp: Stainless steel
- Glass: Sapphire glass with anti-fingerprint coating
- Watch diameter: 44mm
- Wristband width: 22mm
- Display size: 1.1mm
- Watch thickness: 16mm
- Water resistant: 5 ATM
- Built-in rechargeable battery

Sensors

- Accelerometer
- Optical heart rate sensor (PPG)
- 3D magnetometer sensor
- ECG sensor

Metrics and features

- On-demand ECG and SpO2 tracking
- Heart rate tracking
- Sleeping tracking
- Alarm setting
- 24/7 activity tracking
- Pre-loaded sport mode
- Connected GPS
- Notifications
- Weather forecast
- Chrono and timer
- E-compass
- Remote control (Music and Camera)
- Stress level detection
- Breathe training
- Hydration and Sedentary reminder
- Menstrual cycle tracking

Connectivity

- BLE 5.0. You must enable Bluetooth connection with location settings to enjoy GPS tracking functionality.

Compatible OS

- iOS 16.0 or higher
- Android 11 or higher

The Pininfarina Senso cannot be set up from a computer.

International Warranty

Designed, manufactured and distributed by Globics Technology Limited (“Globics”), the official licensee for this product. The Pininfarina name and logo are trademarks of Pininfarina S.p.A. and are used under license. All other trademarks are the property of their respective owners.

Two (2) Years Warranty

Globics warrants the Pininfarina-branded hardware product against defects in materials and manufacturing when used normally following Globics published guidelines for a period of TWO (2) YEARS from the date of original retail purchase by the end-user purchaser. Globics published guidelines include but are not limited to information contained in technical specifications, safety instructions or quick start guide.

Under this warranty, the following items are excluded: Normal wear and tear, any damage on any part of the watch resulting from improper or abusive use, neglect, accidents (knocks, dents, crushing, broken crystal, etc.), incorrect use of the timepiece and non-observance of operating instructions, watches handled by non-authorized persons, defects or damage that result from the use of non-Globics certified products, accessories, software or other peripheral equipment, and watches that have been altered in their original condition outside Globics's control. Under no circumstances will Globics be liable for any direct and consequential damages of any kind. Globics does not warrant that the operation of the Globics Product will be uninterrupted or error-free. Any further claim against Globics for damages additional to the above-described warranty is expressly excluded.

The above manufacturer's warranty is independent of any warranty provided by the seller, which carries sole responsibility; it does not affect the purchaser's rights against the seller nor any other mandatory statutory rights the purchaser may have against the seller.

Regulatory statements

Specific Absorption Rate (FCC & IC)

YOUR WATCH MEETS FCC AND IC LIMITS FOR EXPOSURE TO RADIO WAVES.

Your watch is a radio transmitter and receiver intended to be worn on your wrist. It is designed not to exceed the limits for exposure to radio waves (radio frequency electromagnetic fields) adopted by the Federal Communications Commission (FCC) and Industry Canada (IC). These limits include a substantial safety margin designed to assure the safety of all persons, regardless of age and health. The radio wave exposure guidelines use a unit of measurement known as the Specific Absorption Rate, or SAR. The SAR limit for wrist-worn devices is 4.0 W/kg. Testing is conducted with the device transmitting at its highest certified power level. This equipment complies with FCC & Industry Canada radiation exposure limits set forth for an uncontrolled environment.

Notices & Statements

European Union Directives Conformance Statement



The following CE compliance information is applicable to Globics products that carry one of the following CE marks:

Hereby, Globics declares that this product is in compliance with:

The essential requirements and other relevant provisions of Directive 1999/5/EC
All other relevant EU Directives

The following gives an example of a typical Type name:

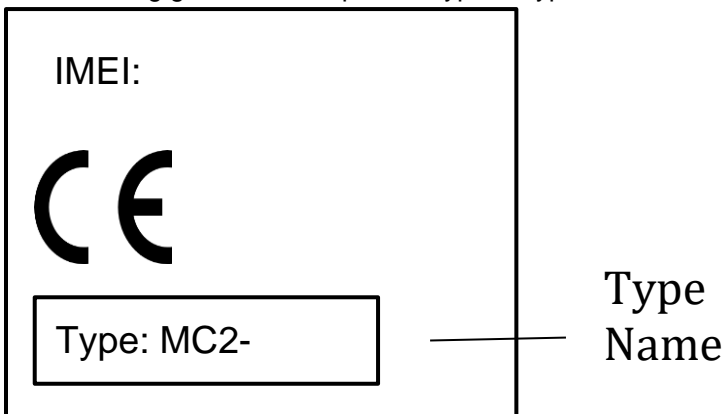

You can view your product's Declaration of Conformity (DoC) at www.pininfarina-hybridwatchbyglobics.com (in English only). To find your DoC, enter the Type the name from your product's label in the "Search" bar on the website.

FCC Notice to Users

The following statement applies to all products that bear the FCC log and/or FCC ID on the product label.

This equipment has been tested and found to comply with the limits for a Class B digital device, pursuant to part 15 of the FCC Rules. See 47 CFR Sec. 15.105(b). These limits are designed to provide reasonable protection against harmful interference in a residential installation. This equipment generates, uses and can radiate radio frequency energy and, if not installed and used in accordance with the instructions, may cause harmful interference to radio communications.

However, there is no guarantee that interference will not occur in a particular installation. If this equipment does cause harmful interference to radio or television reception, which can be determined by turning the equipment off and on, the user is encouraged to try and correct the interference by one or more of the following measures:

Reorient or relocate the receiving antenna.

Increase the separation between the equipment and the receiver.

Connect the equipment to an outlet on a circuit different from that to which the receiver is connected.

Consult the dealer or an experienced radio/TV technician for help.

This device complies with part 15 of the FCC Rules. Operation is subject to the following two conditions:

This device may not cause harmful interference, and

This device must accept any interference received, including interference that may cause undesired operation. See 47 CFR Sec. 15.19(a)(3).

Globics Technology Limited has not approved any changes or modifications to this device by the user. Any changes or modifications could void the user's authority to operate the equipment. See 47 CFR Sec. 15.21.

Industry Canada Notice to Users

This device complies with Industry Canada licence-exempt RSS standard(s). Operation is subject to the following two conditions:

This device may not cause interference and

This device must accept any interference, including interference that may cause undesired operation of the device.

Le présent appareil est conforme aux CNR d'Industrie Canada applicables aux appareils radio exempts de licence. L'exploitation est autorisée aux deux conditions suivantes:

l'appareil ne doit pas produire de brouillage, et

l'utilisateur de l'appareil doit accepter tout brouillage radioélectrique subi, même si le brouillage est susceptible d'en compromettre le Fonctionnement.

See RSS-Gen, Section 8.4. This device complies with ICES-003 requirements for Class B ITE (Information Technology Equipment). CAN ICES-003(B)/NMB-003(B).

Caution: Exposure to Radio Frequency Radiation.

To comply with the Canadian RF exposure compliance requirements, this device and its antenna must not be co-located or operating in conjunction with any other antenna or transmitter.

During testing, PMH01A are set to their highest transmission levels and placed in positions that stimulate use against the head, with 10mm separation, and on the wrist, with no separation. When placing PMH01A near your face, keep at least 10mm of separation to ensure exposure levels remain at or below the as-tested levels.

Attention: exposition au rayonnement radiofréquence.

Pour se conformer aux exigences de conformité RF canadienne l'exposition, cet appareil et son antenne ne doivent pas être co-localisés ou fonctionnant en conjonction avec une autre antenne ou transmetteur.

Durant les tests, les radios de l' PMH01A sont réglées sur le niveau de transmission maximal et sont placées dans des positions simulant une utilisation contre la tête, avec une séparation de 10 mm, et au poignet, sans séparation. Lorsque vous approchez votre PMH01A du visage, gardez une séparation d'au moins 10 mm pour veiller à ce que les niveaux d'exposition ne dépassent pas les niveaux testés.

Canadian Notice

This device contains licence-exempt transmitter(s)/receiver(s) that comply with Innovation, Science and Economic Development Canada's licence-exempt RSS(s). Operation is subject to the following two conditions:

This device may not cause interference.

This device must accept any interference, including interference that may cause undesired operation of the device.

Avis Canadien

L'émetteur/récepteur exempt de licence contenu dans le présent appareil est conforme aux CNR d'Innovation, Sciences et Développement économique Canada applicables aux appareils radio exempts de licence. L'exploitation est autorisée aux deux conditions suivantes :

L'appareil ne doit pas produire de brouillage;

L'appareil doit accepter tout brouillage radioélectrique subi, même si le brouillage est susceptible d'en compromettre le fonctionnement.

EC/UK DECLARATION OF CONFORMITY

CE and UKCA:

- EN 62479: 2010
- EN 61326-1:2013
- EN 301 489-1 V2.2.3 (2019-11)
- EN 301 489-17 V3.2.4 (2020-09)
- EN 300 328 V2.2.2 (2019-07)
- BS EN 62479: 2010
- BS EN 61326-1:2013
- ETSI EN 301 489-1 V2.2.3 (2019-11)
- ETSI EN 301 489-17 V3.2.4 (2020-09)
- ETSI EN 300 328 V2.2.2 (2019-07)
- EN 62368-1:2014+A11:2017, BS EN 62368-1:2014+A11:2017

FCC:

- CFR47 FCC Part 15: Subpart C Section 15.247 RSS-247 Issue 2 February 2017
- CFR47 FCC Part 15: Subpart C Section 15.207 RSS-Gen Issue 5 February 2021
- CFR47 FCC Part 15: Subpart C Section 15.209 RSS-102 Issue 5 February 2021
- CFR47 FCC Part 2.1093
- CFR47 FCC Part 15: Subpart B Section 15.107
- CFR47 FCC Part 15: Subpart B Section 15.109
- ICES-003 Issue 7 October 2020

United States:

- U.S. Department of Energy – Energy Conservation Standards for Battery Chargers 10 CFR Part 430.32(z)
- CAN/CSA-C381.2-17- Energy performance of battery-charging systems and uninterruptible power supplies;
- Uniform Test Method for Measuring the Energy Consumption of Battery Chargers: 10 C.F.R. section 430.23(aa) (Appendix Y to Subpart B of Part 430)

U.S. California:

- Safe Drinking Water and Toxic Enforcement Act of 1986 (Proposition 65): Lead content
- Safe Drinking Water and Toxic Enforcement Act of 1986 (Proposition 65): Phthalates
- Phenol, isopropylated phosphate (3:1) [PIP (3:1)]. Decabromodiphenyl ether (DecaBDE), Hexachlorobutadiene (HCBd), Pentachlorothiophenol (PCTP) and 2,4,6-tris (tert-butyl) phenol (2,4,6-TTBP) Content – Persistent, Bioaccumulative, and Toxic (PBT) Chemicals Under US Toxic Substances Control Act (TSCA) Section 6(h)
- U.S. California Appliance Efficiency Regulations – Battery Charger System

The product is labelled with the Approval Marking CE/FCC/IC/UKCA as shown. Any unauthorized modification of the product voids this Declaration.

EU regions importer: Globics Technology Europe BV

Address: Diamantstraat 8, Bus 214-2200, Herentals, Belgium

UK region importer: Globics Technology (UK) Limited.

Address: 6 Prospect way Royal Oak Industrial Estate, Daventry, Northamptonshire,
United Kingdom NN11 8PL

Document release

Release date	Versions	Modifications
February 2023	V1.0	First release
September 2023	V1.1	Instruction information update

This document is prepared by Globics Technology Limited

Notes: The screenshots in this manual are used for explanatory purposes. Your actual screens may differ from screenshots in this manual.